

Article number: 439600120

Description: Rota-fix shaft-hub connection FS120x165

Note: Self centering - very high torque.

Measures

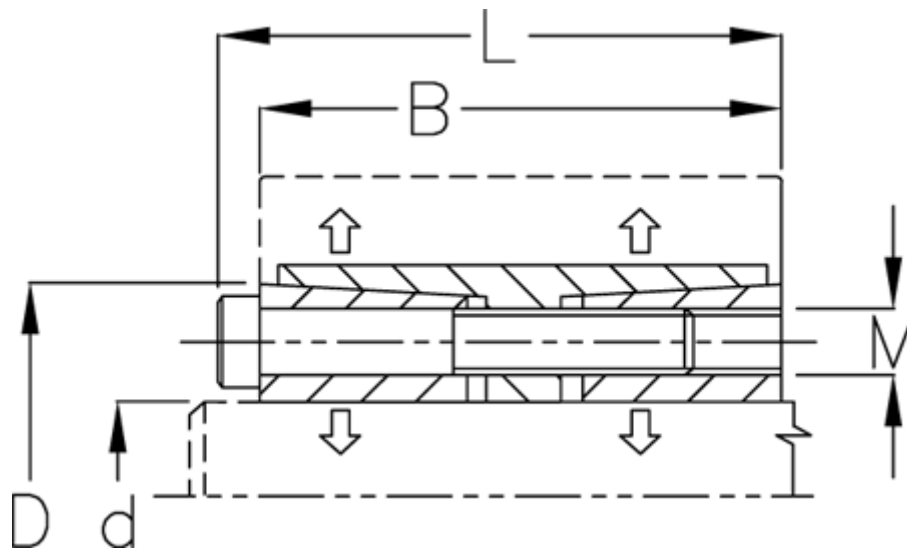

B mm	= 72
d H8 mm	= 120
D mm	= 165
Fit tolerance	= Aksel h8, Nav H8
F kN torque	= 427.0
L mm	= 84
M mm	= M12
P N/mm ² surface pressure on shaft/hub	= 144

Surface roughness	= R? ? 3.2 μ m
T N m torque	= 25600
Ts N m bolt tightening torque	= 145.0